

DIN 906
Locking screws

Hexagon socket

Stainless steel A4 | Cr(VI)-free | Metric conical fine thread

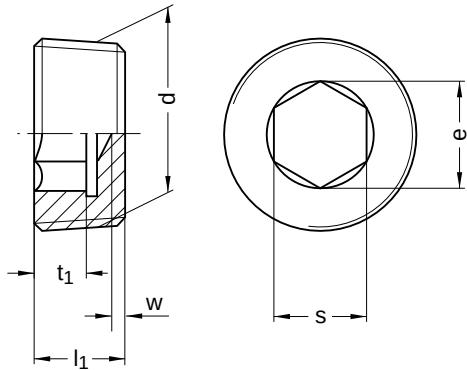

Diameter (d)	l ₁	e min.	s nominal size	Pitch (P)	t ₁ min.	w min.	Tool size
M8 x 1	8	4.6	4	1.0	4	1.8	SW 4
M10 x 1	8	5.7	5	1.0	4	1.8	SW 5
M12 x 1.5	10	6.9	6	1.5	5	2.0	SW 6
M14 x 1.5	10	8.0	7	1.5	5	2.0	SW 7
M16 x 1.5	10	9.2	8	1.5	5	2.0	SW 8
M18 x 1.5	10	9.2	8	1.5	5	2.0	SW 8
M20 x 1.5	10	11.4	10	1.5	5	2.0	SW 10
M22 x 1.5	10	11.4	10	1.5	5	2.0	SW 10
M26 x 1.5	12	13.7	12	1.5	6	2.0	SW 12
M27 x 2	12	13.7	12	2.0	6	2.0	SW 12
M30 x 1.5	12	19.4	17	1.5	6	2.0	SW 17
M30 x 2	12	19.4	17	2.0	6	2.0	SW 17

All technical data refer to the measure mm

